

MXL Disc Brake Caliper - Spring Applied, Hydraulically Released

Nominal dimensions given
For caliper dimensions see DS2500

DS2500

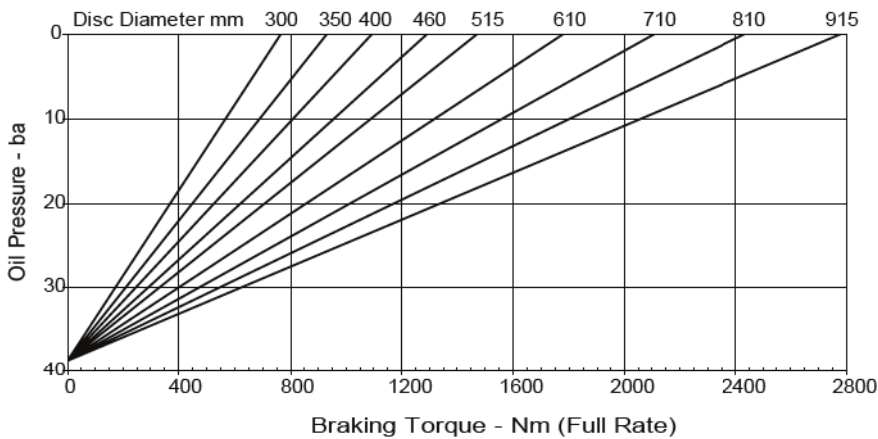
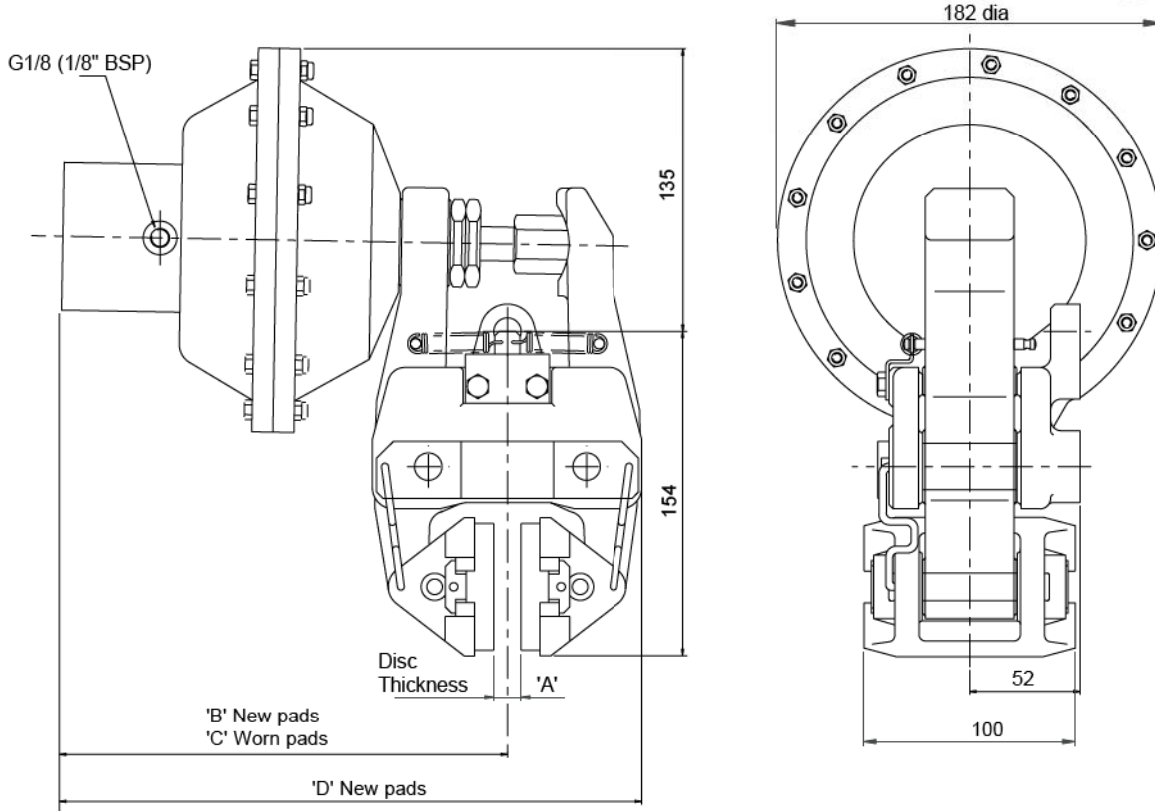

Caliper	Dimensions in mm			
	'A'	'B'	'C'	'D'
MXL 13	13	221.5	229.5	286.5
MXL 25	25	226	234	293
MXL 30	30	221.5	229.5	292.5
MXL 40	40	226	234	301

Weight (caliper and thruster) - 11kg
(thruster only) - 4kg

Volume displacement of thruster at 4mm retraction is 5ml

Maximum Working Pressure 120 bar

Rate	Maximum Braking Force - kN	Minimum Pressure for Full Retraction - bar
Full	6.5	50
2/3	4.4	34
1/3	2.2	17

The ratings shown on the above graph are based on fully bedded and conditioned brake pads with nominal friction coefficient $\mu = 0.4$.

For bedding-in and conditioning procedures see Publication M1060.

Braking Force is defined as the Tangential Force acting on the brake disc at the Effective Disc Radius.

Braking Torque (Nm) = Braking Force (N) x Effective Disc Radius (m) where Effective Disc Radius = Actual Disc Radius - 0.033.

Twiflex Disc Brakes must be used with Twiflex asbestos free brake pads. The use of any other brake pads will invalidate the warranty. Twiflex Limited reserves the right to modify or change the design without prior notice.

MXL Disc Brake Caliper - Spring Applied, Hydraulically Released

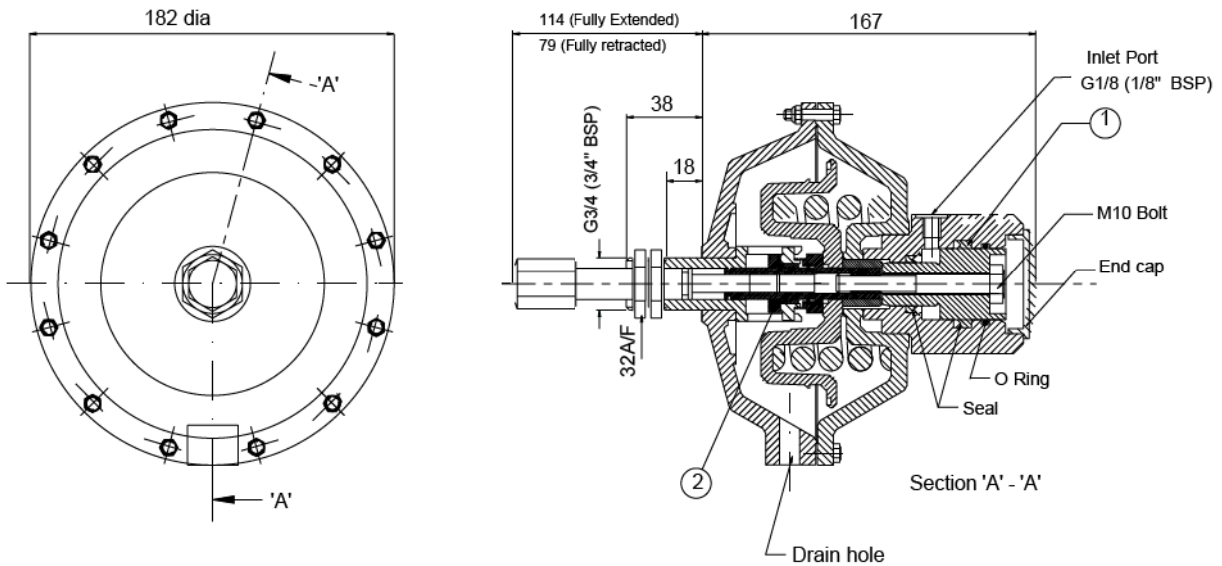

AVAILABLE SPARES		
Item	Component	Part No.
1	Seal Kit	7902806
2	Self Adjusting Repair Kit	7902805

Thruster Part Number:
Full Rate 750092/AH37
2/3rd Rate 7500102/AH38
1/3rd Rate 7500101/AH39

Depending upon the service conditions it may eventually become necessary to replace the hydraulic seals. This is done as follows:

- Remove thruster from caliper.
- Unscrew and remove the pushrod.
- Remove the end cap from the rear of the thruster.(see drawing above)
- Unscrew M10 bolt. (see drawing above)
- Gently apply hydraulic pressure at inlet port to ease the piston out of the cylinder.
- The seal and O Ring can now be replaced on the piston and also the one in the cylinder. (see drawing above)
- Lightly grease the seals and replace piston and lock in position with M10 bolt, tightening torque 46Nm. (use Loctite)
- Replace the end cap and the thruster is ready for service.

Thruster fitment

- Make sure the thruster rod is extended i.e. it is not pressurised.
- Take hold of the thruster and turn the push rod via the hex portion clockwise until it stops rotating: so a 'clicking' can be heard from the ratchet. **Do this by hand,do not apply heavy force to push the rod once it stops turning.**
- Offer thruster to caliper making sure that both lock nuts are removed before placing hex section of push rod through caliper arm.
- Pull caliper arms apart so that the pads are hard against the disc.
- Fit lock nuts to thruster body loosely and unwind push rod until the gap between the body and the arm is 6mm. Make sure that the hex section of the push rod is within the slot of the other arm.
- Tighten first lock nut to 50 - 60Nm then tighten the second nut against the first.
- Fit tension spring to arms.

